

# Patio

DESIGN ROBERT BRONWASSER

## PATIO TYPES / PATIO TYPEN

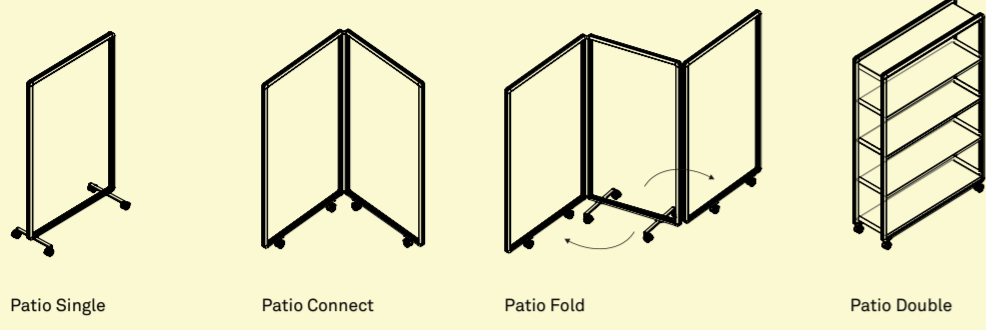

## FRAME DIMENSIONS (HEIGHT WITHOUT BASE) / RAHMEN DIMENSIONEN (HÖHE OHNE GESTELL)

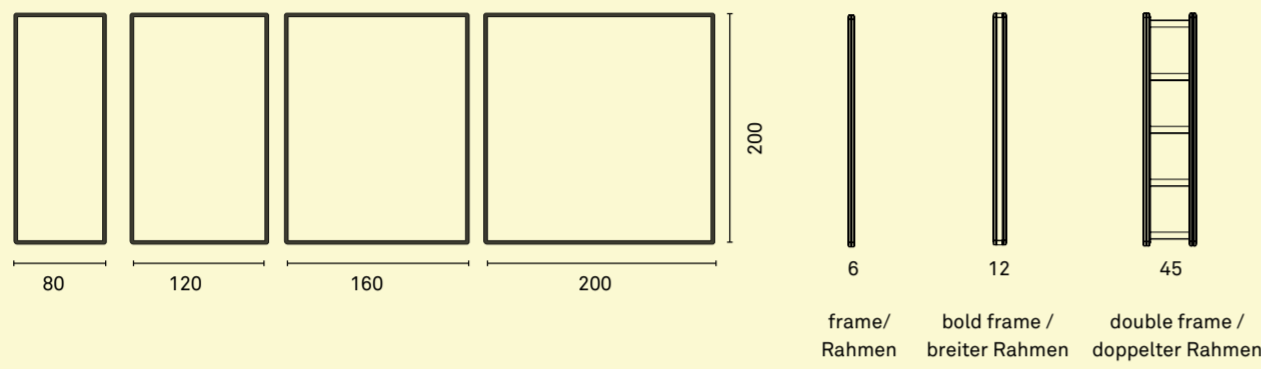

## MOBILE BASE / MOBILES GESTELL

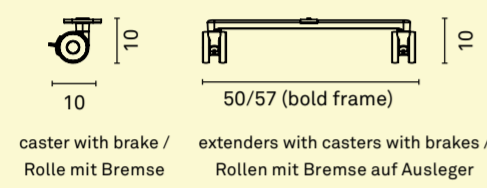

## FIXED BASE / FESTES GESTELL

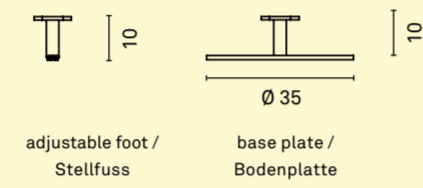

## CORNER CONNECTIONS / ECKVERBINDER

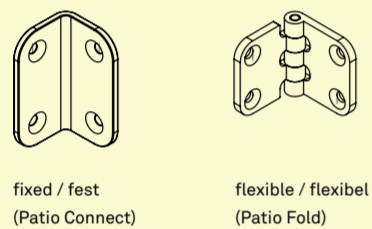

## CONTENT / INHALT

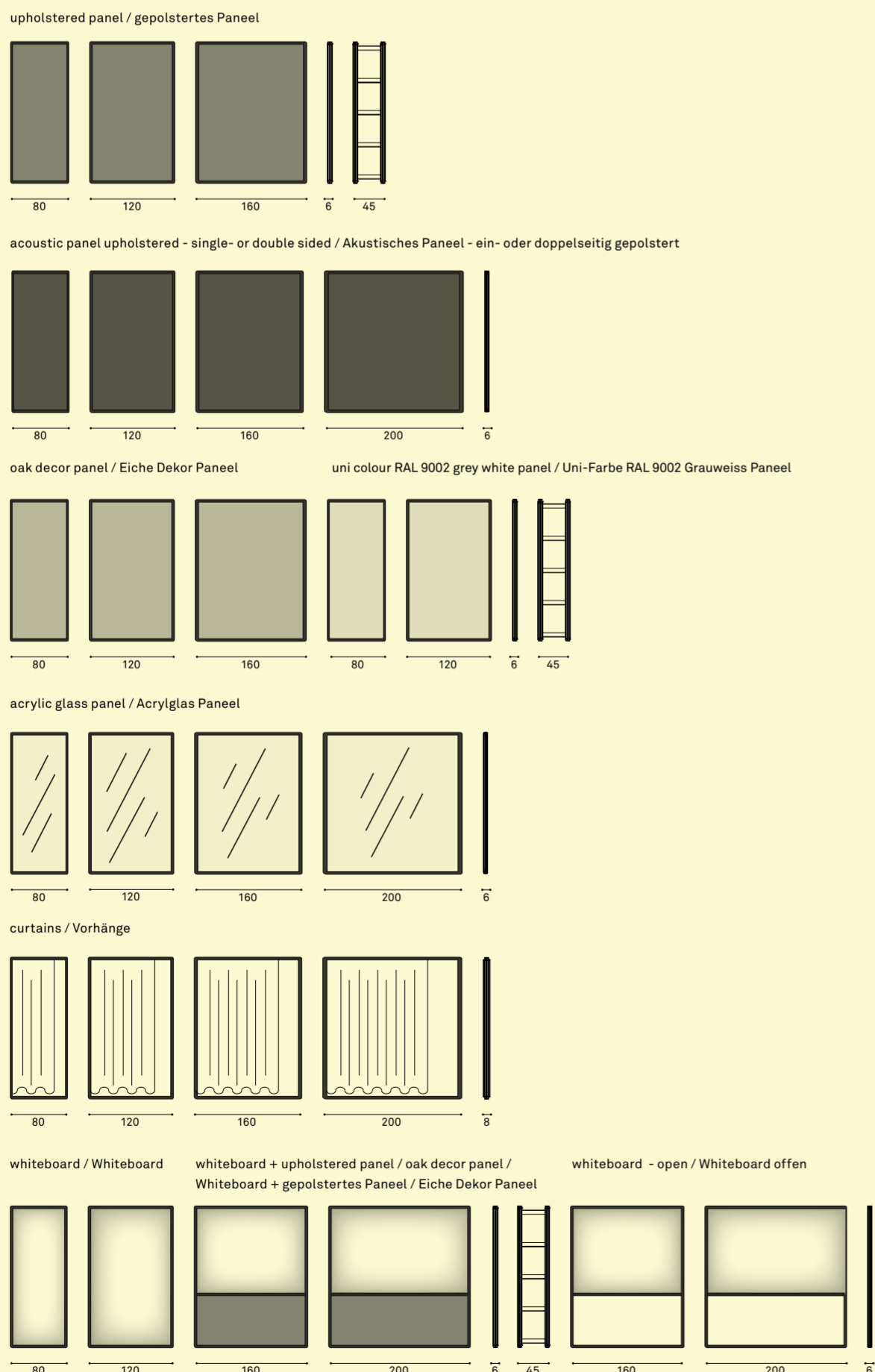

## CONFIGURATIONS / KONFIGURATIONEN

Patio Single

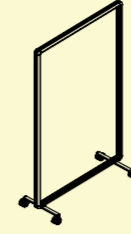

Patio Connect

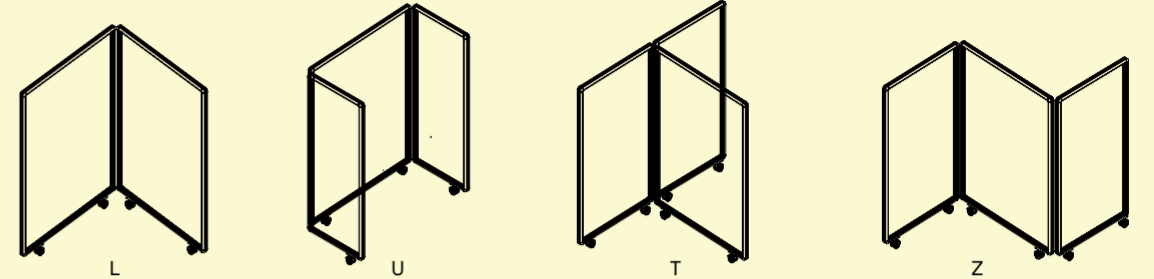

Patio Fold

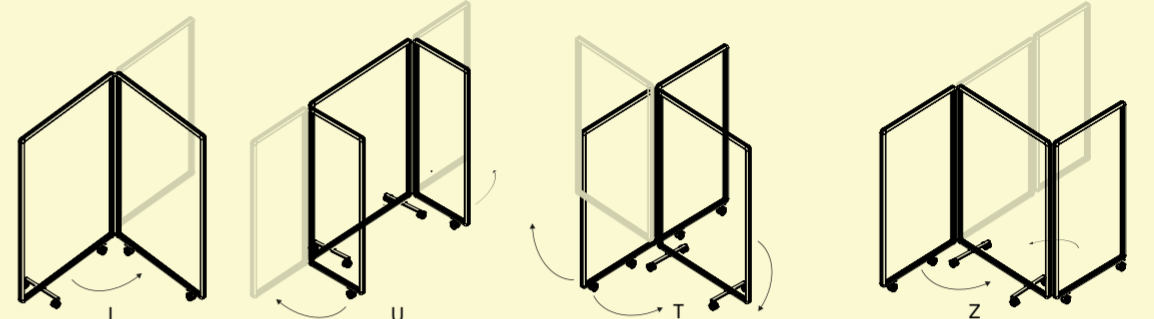

Patio Double

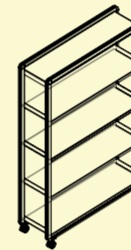

## MATERIALS / MATERIALIEN

**FRAME / RAHMEN**  
aluminium, powder coated with light structure  
Aluminium, pulverbeschichtet mit Feinstruktur

**ACOUSTIC PANEL / AKUSTISCHES PANEEL**  
100% recycled cotton + fabric group P0, P1, P2  
100% recycelte Baumwolle + Stoffgruppe P0, P1, P2

**SHELVES AND TRAYS / ABLAGEN UND STAUFÄCHER**  
steel, powder coated with light structure  
Stahl, pulverbeschichtet mit Feinstruktur

**WARDROBE BAR AND HOOKS / GARDEROBENSTANGE UND HAKEN**  
aluminium, powder coated with light structure  
Aluminium, pulverbeschichtet mit Feinstruktur

**UPHOLSTERED PANEL / GEPOLSTERTES PANEEL**  
MDF panel + fabric group P0, P1, P2  
MDF Paneel + Stoffgruppe P0, P1, P2

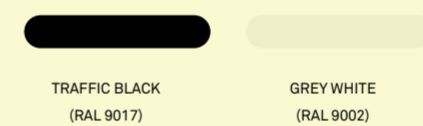

## screen support open / LCD-Halterung offen

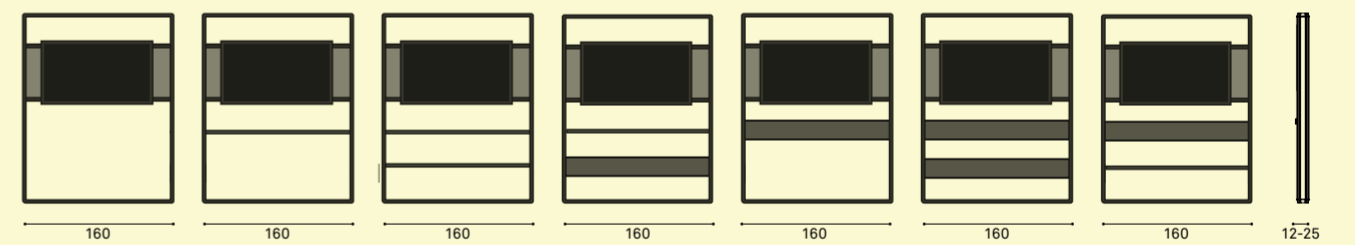

## screen support with upholstered panel / LCD-Halterung mit gepolstertem Paneel

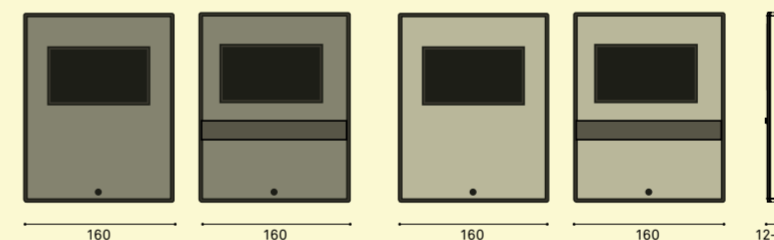

## magazine tray(s) / Broschürenhalter

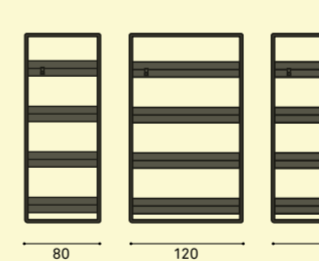

## magazine tray(s) - with upholstered panel / Broschürenhalter mit gepolstertem Paneel

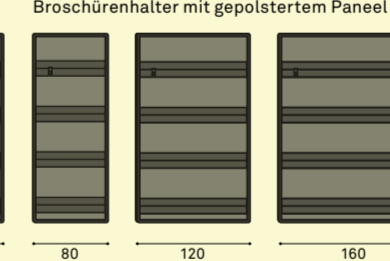

## trays - h 15 x d 12 cm (4 pieces) / Staufächer - h 15 x t 12 cm (4 Stück)

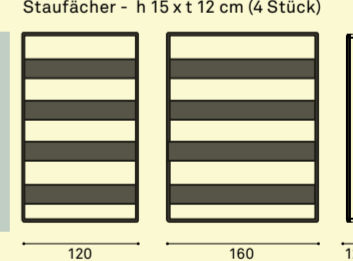

## shelves - d = 25 cm (4 pieces) / Ablagen - t = 25 cm (4 Stück)

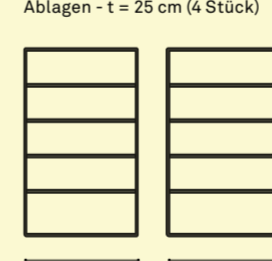

## shelves - depth 38 cm / Ablagen - 38 cm tief

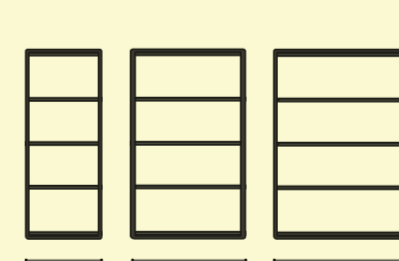

## shelves with upholstered panel - depth 38 cm / Ablagen mit gepolstertem Paneel - 38 cm tief

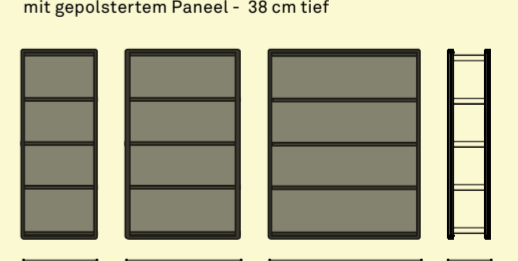

## wardrobe rail for coat hangers / Garderobenstange für Kleiderbügel

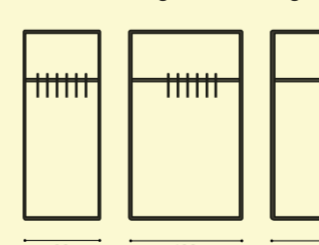

## wardrobe rail with double sided coat hooks / Garderobenstange mit doppelseitigen Mantelhaken

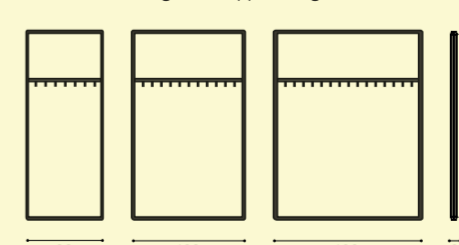

## cables for planters - adjustable / Drahtseile für Pflanzen, verstellbar

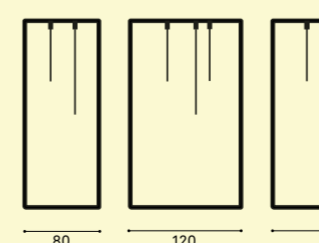

## planter trays h 15 x d 12 cm (4 pieces) / Pflanzenträge h 15 x t 12 cm (4 Stück)

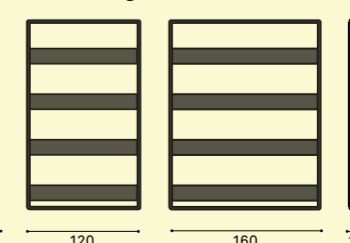

Cascando